

# MANUAL

## BUTCHER BLOCK & DRESSOIR

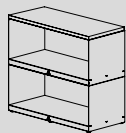
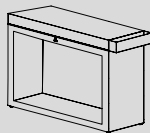
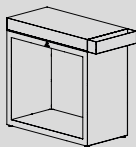
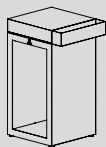
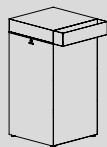

## OFYR® MANUAL BUTCHER BLOCKS

THANK YOU SO MUCH FOR BUYING AN OFYR® PRODUCT. THIS MANUAL CONTAINS SETUP INSTRUCTIONS, WARRANTY CONDITIONS, AND ADDITIONAL INFORMATION ABOUT YOUR OFYR BUTCHER BLOCK.

---

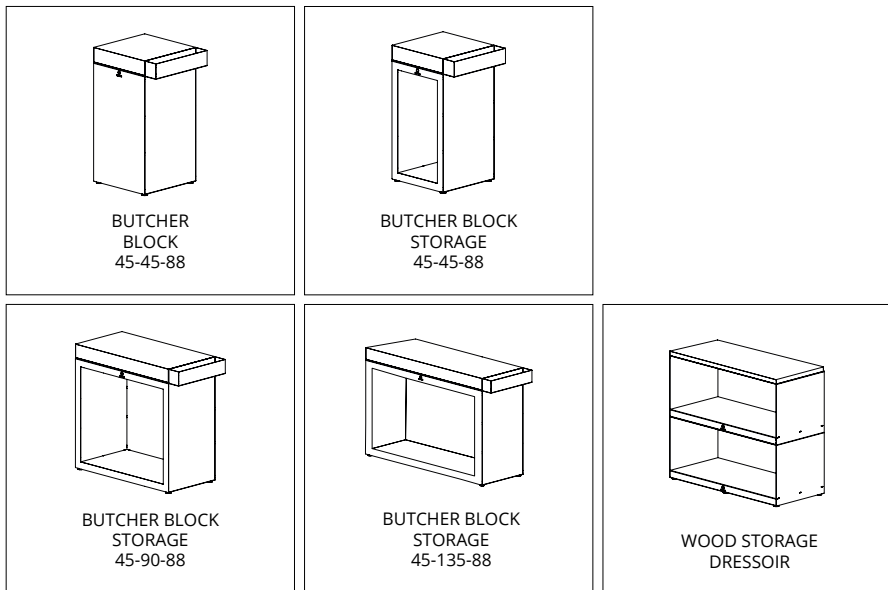

### BUTCHER BLOCKS

The OFYR® Butcher Block includes a solid wood chopping board for food preparation, handy accessories tray and options for under-counter wood storage. The wooden boards must be cleaned by hand and must not be treated with any corrosive substances or cleaned in the dishwasher. After you clean them, we recommend that you store them inside, in a dry place with low humidity. Large temperature differences may cause the wood to warp. We strongly advise against leaving these wooden boards outside. Please note that wood is a natural product and is always liable to warp somewhat. We are not liable for any wood warping that may occur. All wooden boards on Butcher Blocks are equipped with magnets, ensuring that the wooden board stays in place and yet can be easily removed once you are done cooking. If the surface is not entirely level, you can use the adjustable feet of the OFYR® Butcher Blocks to make sure that it is level. Once the OFYR® Butcher Blocks have been set up, they must not be shifted. Shifting them could cause damage to the adjustable feet or the rivet nuts with which the adjustable feet are attached. We do not accept warranty claims or liability for any damage resulting from shifting the OFYR® Butcher Blocks.

Please note that if the adjustable feet are extended too far, the OFYR® Butcher Blocks may become unstable. We recommend a maximum difference in level of 10 mm. If the level difference exceeds 10 mm, we recommend levelling the surface before setting up the OFYR® unit.

## Disclaimers

### CORROSION

With the exception of the cooking plates, adjustable feet, hinges, screws, and the magnets underneath the wooden planks, all steel elements of the OFYR® collection are made of Corten steel. Corten steel is a type of steel that corrodes very rapidly, and it is precisely this corrosion that protects it against rust perforation. If you allow nature to take its course, it will take 6-12 months for these Corten steel elements to corrode, depending on their location and the humidity level. Unlike many manufacturers of Corten steel products, we provide buyers of our products with an additional service by making sure that the corrosion process has already started by the time our products are delivered. Depending on their location and the humidity level, it will take another 3-6 months for this superficial corrosion to turn into a proper layer of corrosion. However, this does not guarantee an entirely smooth layer of corrosion. Therefore, any Corten steel elements that are less corroded than others upon delivery are not eligible for replacement. After all, they will corrode naturally over time under influence of the weather. While the corrosion is still superficial, the Corten steel elements may cause orange stains on clothes, skin, and the surface they stand on. When it rains, corrosive water may also run off these elements, which may permanently stain light-toned stone or wooden surfaces. Under normal circumstances, the Corten steel will gradually develop a smooth, dark brown layer of corrosion that will not chip. However, this layer may chip in locations near the sea or the shore due to the high levels of salinity in such locations. The chipping will not cause any damage, but the chipped corrosion must be removed to prevent corrosion from forming on the surface the OFYR® unit is placed on.

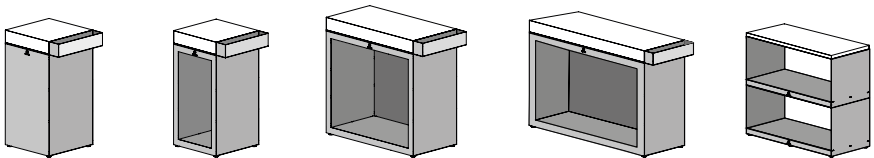

### WOODEN BOARDS

Some OFYR® products include wooden boards to be used as seating or work surface. None of those should be left outside for extended periods of time. Humid weather may cause them to warp and/or crack. We therefore recommend that you store these boards inside in a dry place after each use. We do not recommend leaving them outside at night, as the weather tends to be humid then. The work surfaces can be used as cutting boards, but should not be used as chopping blocks. If sharp or heavy objects are used to exert great force on these surfaces, these will become irreparably damaged. The work surfaces that come with the OFYR® Butcher Blocks 45-45-88 and the OFYR® Island 85-100 are the same size. The work surfaces that come with the OFYR® Butcher Blocks have magnetic feet and those that come with the OFYR® Island 85-100 have nylon feet. The OFYR® Butcher Blocks work surfaces are not suitable for use on the OFYR® Island 85-100 because the magnetic feet are conductive, and the conducted heat may cause the wood to warp. We do not accept liability for any damage resulting from incorrect use of wooden boards. Please note that you should not place OFYR® products with wooden elements directly next to any heat source, including any of our OFYR® cooking units, because the heat may cause damage to the wood or cause it to warp.

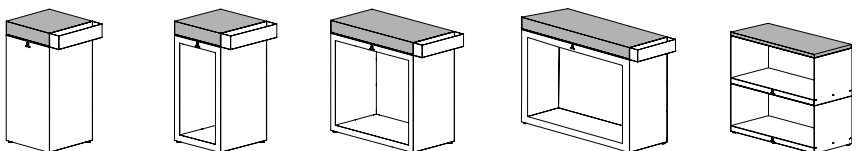

**ADJUSTABLE FEET ON OFYR® COOKING UNITS, BUTCHER BLOCKS, HOCKER, BENCH AND DRESSOIR**

Once OFYR® cooking units, Butcher Blocks, Hocker, Bench, and Dressoir have been set up, the adjustable feet can be used to make them level. We do not recommend using these feet to adjust the overall height of our OFYR® cooking units and other units, because the OFYR® cooking units, Butcher Blocks, Hocker, Bench, and Dressoir may become unstable if the adjustable feet are extended by more than 10 mm. We do not accept liability for any damage resulting from improper use of adjustable feet. Once the OFYR® cooking units, Butcher Blocks, Hocker, Bench, and Dressoir have been set up, they must not be shifted. Shifting them could cause damage to the adjustable feet or the rivet nuts with which the feet are attached. We do not accept warranty claims or liability for any damage resulting from shifting and/or moving the OFYR® cooking units, Butcher Blocks, Hocker, Bench, and Dressoir.

.....

## Warranty terms per element

A limited lifetime warranty applies to the material and construction of all steel elements of all OFYR® units for the original buyers or owners, provided that they purchased their unit from an authorised dealer and registered their warranty in the required manner.

	<b>B2C</b>	<b>B2B</b>
<b>WEATHERED STEEL ELEMENTS, EXCEPT THE WEATHERED STEEL CONE</b>	<b>5 YEARS</b>	<b>3 YEARS</b>
<b>WOODEN BLOCKS AND PLANKS</b>	<b>2 YEAR</b>	<b>1 YEAR</b>
<b>PLASTIC ELEMENTS</b>	<b>2 YEARS</b>	<b>1 YEAR</b>
<b>IRON ELEMENTS</b>	<b>2 YEAR</b>	<b>1 YEAR</b>

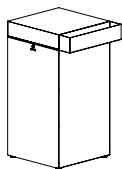

BUTCHER BLOCK 45-45-88

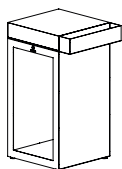

BUTCHER BLOCK STORAGE 45-45-88

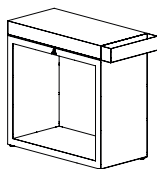

BUTCHER BLOCK STORAGE 45-90-88

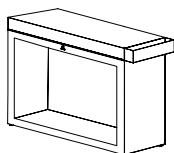

BUTCHER BLOCK STORAGE 45-135-88

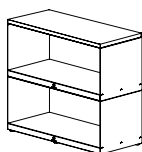

WOOD STORAGE DRESSOIR

## Several models

Butcher Blocks and DRESSOIR

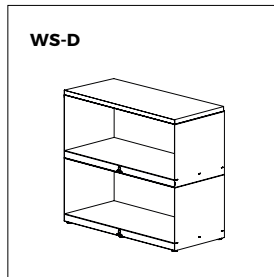
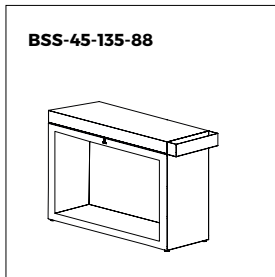
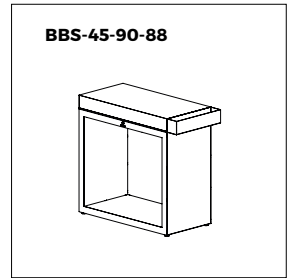
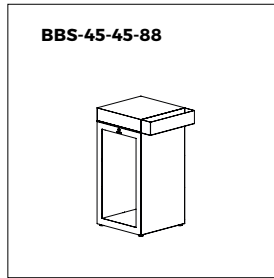
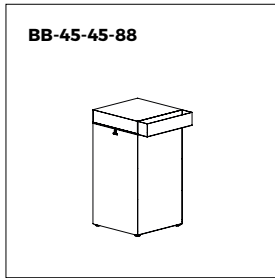

---

## Dimensions

Butcher Blocks and DRESSOIR

### BB-45-45-88

BB-45-45-88

1x

**Material**

Base & tray  
Tabletop

Corten steel  
Rubberwood

**Dimensions**

Height  
Width  
Depth

88 cm  
45 cm  
45 cm

**Weight**

± 41 kg

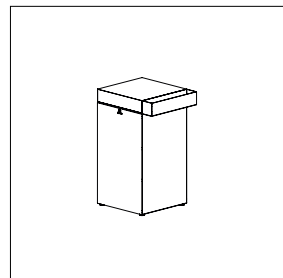

**BBS-45-45-88****BBS-45-45-88**

1x

<b>Material</b>	Base & tray	Corten steel
	Tabletop	Rubberwood
<b>Dimensions</b>	Height	88 cm
	Width	45 cm
	Depth	45 cm
<b>Weight</b>		± 52 kg

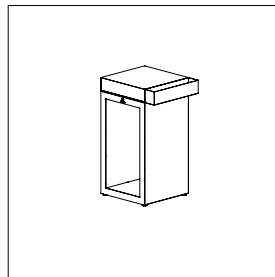
**BBS-45-90-88****BBS-45-90-88**

1x

<b>Material</b>	Base & tray	Corten steel
	Tabletop	Rubberwood
<b>Dimensions</b>	Height	88 cm
	Width	90 cm
	Depth	45 cm
<b>Weight</b>		± 74,1 kg

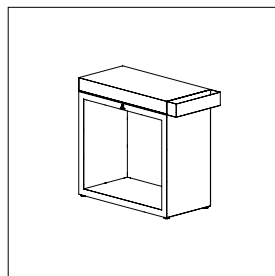
**BBS-45-135-88****BBS-45-135-88**

1x

<b>Material</b>	Base & tray	Corten steel
	Tabletop	Rubberwood
<b>Dimensions</b>	Height	88 cm
	Width	135 cm
	Depth	45 cm
<b>Weight</b>		± 98 kg

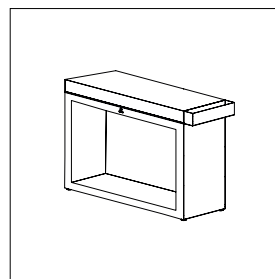
**WS-D****BBS-45-45-88**

1x

<b>Material</b>	Base	Corten steel
	Tabletop	Rubberwood
<b>Dimensions</b>	Height	88,4 cm
	Width	100 cm
	Depth	45 cm
<b>Weight</b>		± 61 kg

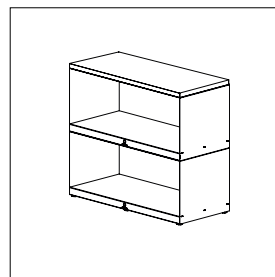

# Building instructions

BB-45-45-88 and BBS-45-45-88

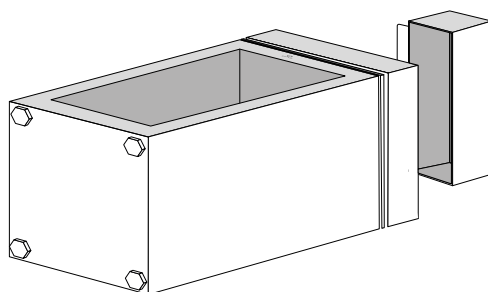
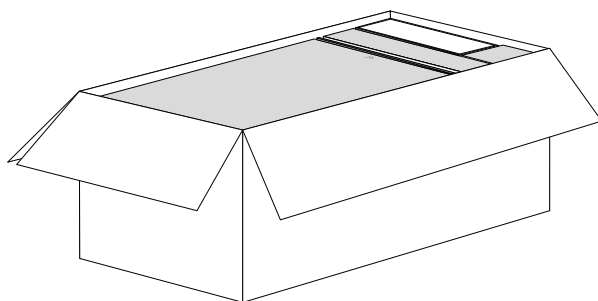
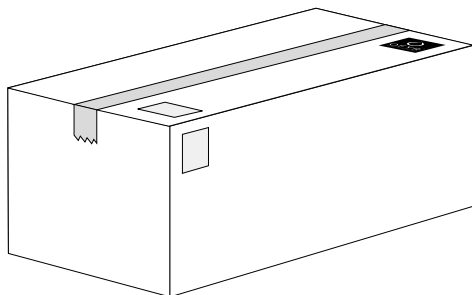





BB-45-45-88

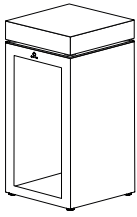

BBS-45-45-88

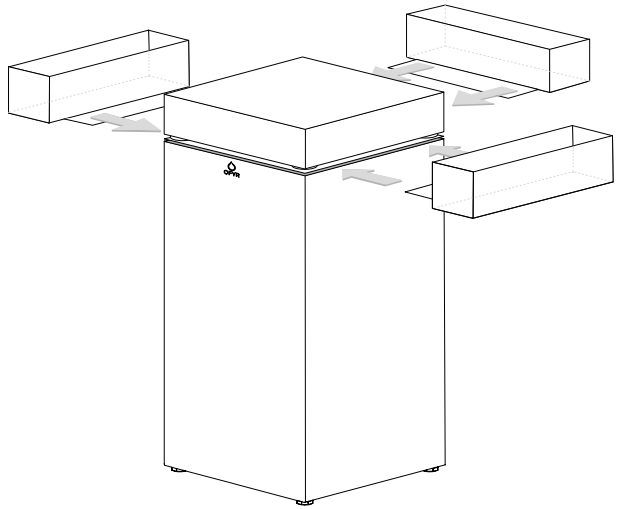

02

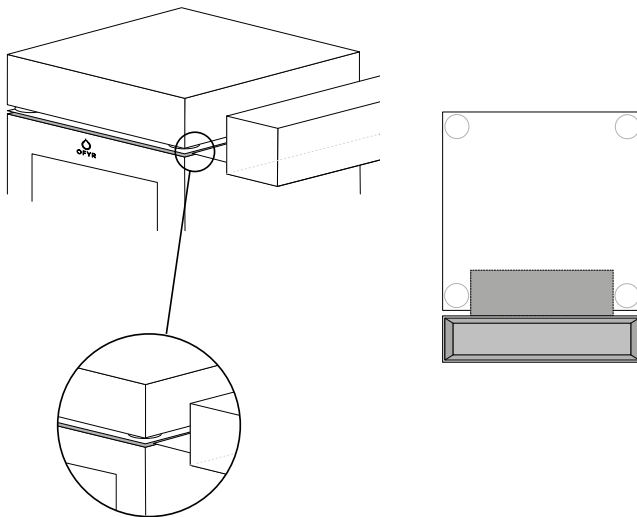

03

# Building instructions

BBS-45-90-88 & BBS-45-135-88

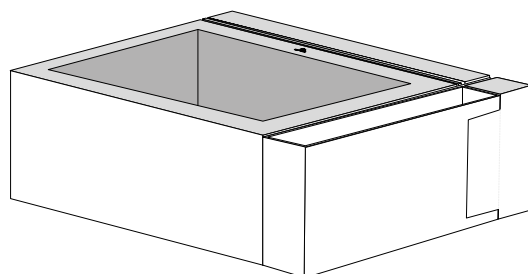
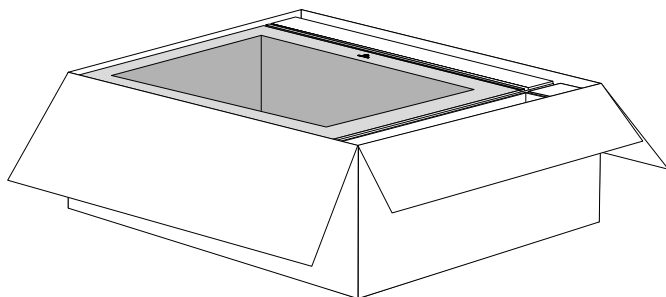
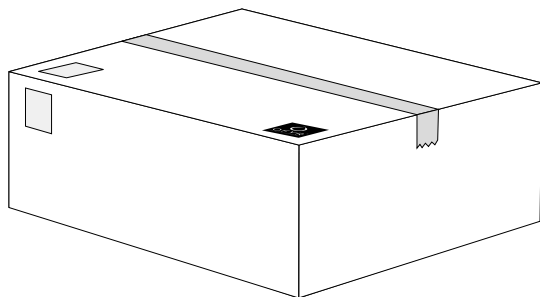

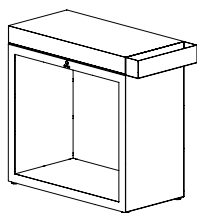

^  
BBS-45-90-88

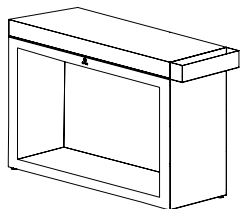

^  
BBS-45-135-88

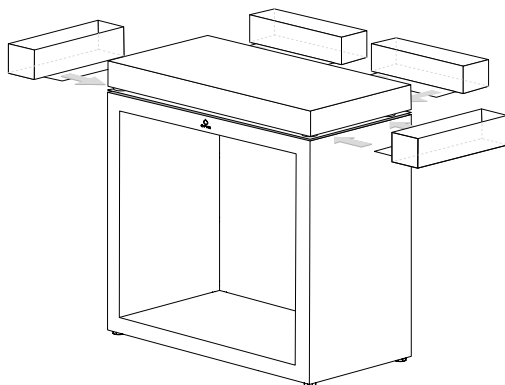

02

---

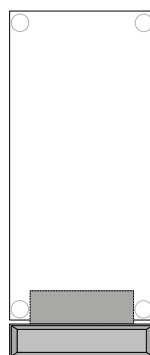
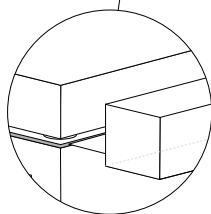
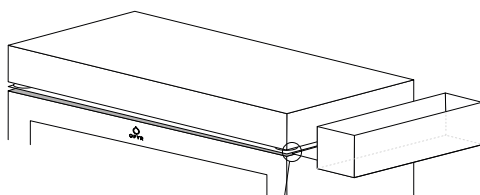

# Building instructions

WS-D

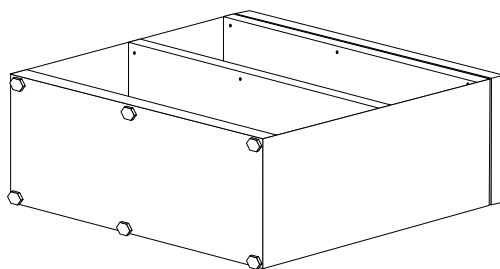
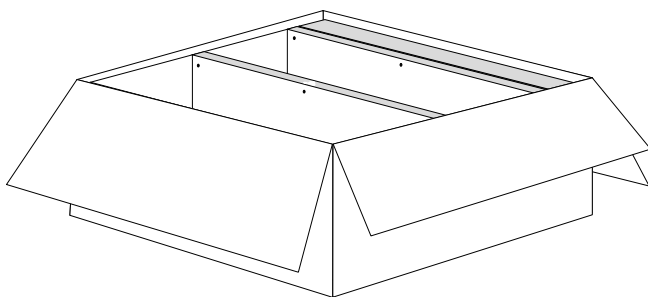
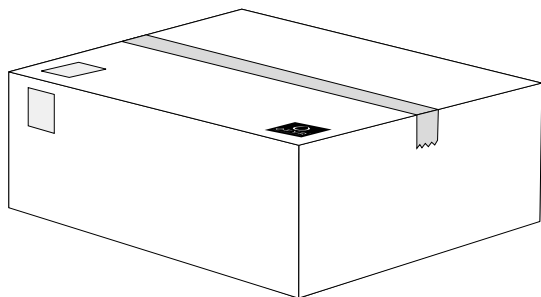

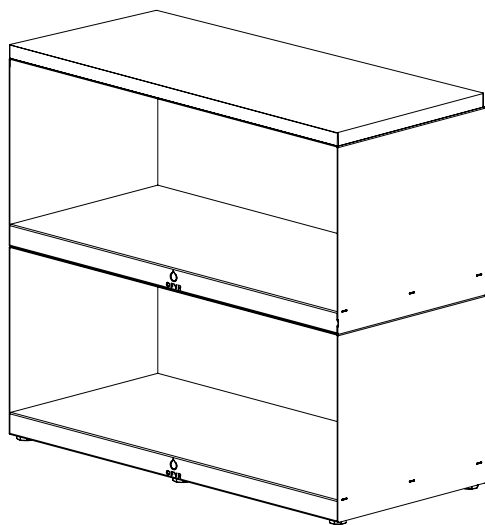





For further information, please contact  
one of our official distributors as listed  
in our online Store Locator:  
[www.ofyr.com/store-locator](http://www.ofyr.com/store-locator)

**Copyright OFYR.**

All rights reserved.

**Creative Outdoor Products B.V.**

Gewenten 43A  
4704 RE Roosendaal  
Nederland

+31 (0)165 74 31 10  
[info@ofyr.com](mailto:info@ofyr.com)  
[www.ofyr.com](http://www.ofyr.com)

The design of some OFYR products have EU registration  
under no 002580431-0001/2 and no 003122373-0001.  
A US Design patent is registered under no US D798,099 S.

